

SPECIFICATION SHEET

COLLECTION: SAFARI

PRODUCT CODE: DX-272251-SAF-CP



SHOWER TYPE

Shower Packages

COLLECTION NAME

Safari

FINISH

Chrome

MINIMUM OPERATING PRESSURE

0.2 Bar LP

MAXIMUM OPERATING PRESSURE

5.0 Bar HP

GUARANTEE

15 Year Guarantee

PLUMBING SYSTEM SUITABILITY

Gravity System, Pumped System, Combination Boiler, Pressurised System

SPARE PARTS

Thermostatic cartridge: V-704-34S. Diverter cartridge: C-803-33X/3X

CONNECTIONS / FITTINGS

Valve: 2 x 3/4" female inlets, 2 x 3/4" female. Head: 1/2" female inlet. Mini kit: 1/2" male 51mm threaded inlet connection

tel: 01934 744466
email: sales@vado.com
www.vado.com

WHERE INSPIRATION FLOWS
TAPS | SHOWERS | FURNITURE



SPECIFICATION SHEET

COLLECTION: SAFARI

PRODUCT CODE: DX-272251-SAF-CP

WITH AIR-INJECTION TECHNOLOGY

No

SHOWER PACKAGE DESCRIPTION

Lever 2 Outlet Concealed Thermostatic Shower Valve (SAF-248D/2-CP)

260mm (10") Rainfall Shower Head (SAF-HEAD-260-CP)

Easy-Fit Shower Arm (SAF-EFSA-CP)

Mini Kit with Pencil Handset, 150cm Hose, Bracket and Integrated Outlet (SAF-SFMKWO-CP)

KIT COMPRISES

1 x Shower Valve, 1 x Shower Head, 1 x Shower Arm, 1 x Mini Shower Kit

WITH THERMOSTATIC TECHNOLOGY

Yes

NUMBER OF OUTLETS

2 Outlet

VALVE TYPE

Concealed

INCLUDES MORTAR / TILE GUARD

No

WITH BLEED VALVE FOR SYSTEM FLUSH ON INSTALLATION

No

COMPATIBLE WITH STUDFAST

No

ADJUSTABLE FIXING FOR EASY RETRO FIT

No

TECHNICAL DRAWING

COLLECTION: SAFARI

PRODUCT CODE: DX-272251-SAF-CP

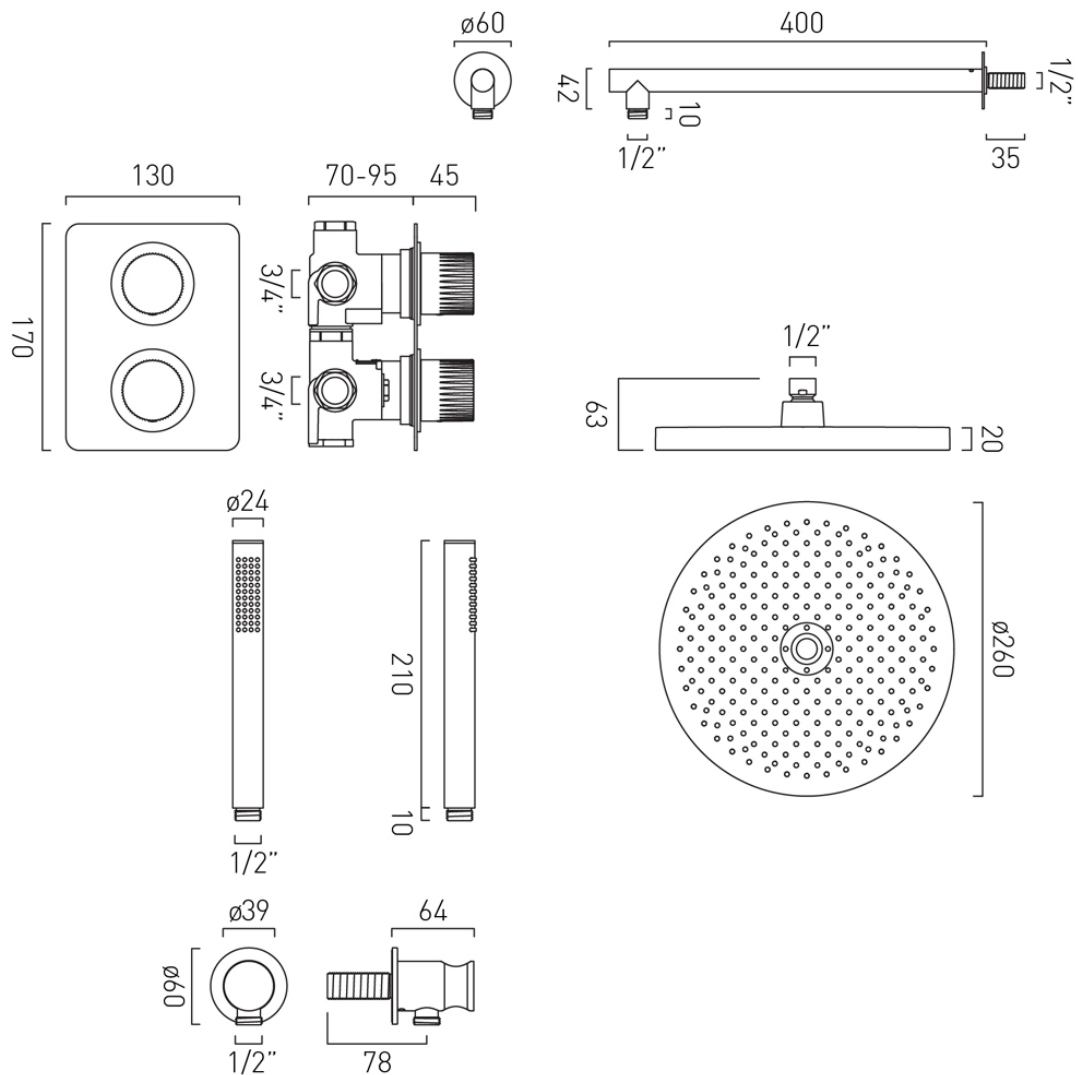

tel: 01934 744466
email: sales@vado.com
www.vado.com

WHERE INSPIRATION FLOWS
TAPS | SHOWERS | FURNITURE

