

# SPECIFICATION SHEET

**COLLECTION:** ELEMENTS

**PRODUCT CODE:** ELE-148D/3-C/P



## DESCRIPTION:

DX Elements  
concealed 3 outlet, 2 handle thermostatic shower valve with integrated diverter  
wall mounted  
with circular backplate  
thermostatic cartridge V-001C-PLA  
diverter cartridge FL-804-33X/3X  
2 x 3/4" female inlets  
3 x 3/4" female outlets  
includes 3/4" - 1/2" adaptors  
inc. bleed valve for system flush on installation  
min-max wall mount 70-95mm  
optimum installation depth 82mm  
minimum operating pressure 0.2 bar LP (shower)  
minimum operating pressure 1.0 bar MP (bath)

## FINISH:

Chrome

## FLOW REGULATOR:

N

## MINIMUM OPERATING PRESSURE:

0.2 bar LP (shower) 1.0 bar MP (bath)

## FLOW RATE AT 3.0 BAR FLOW PRESSURE:

30 l/min

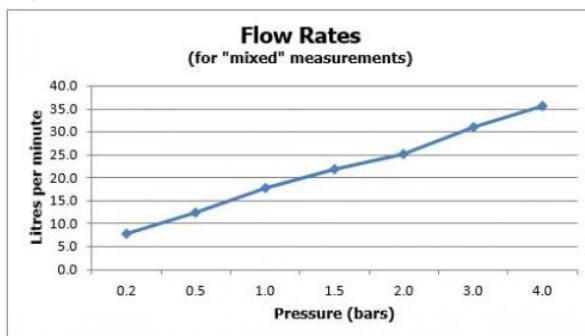

15 year guarantee

tel: 01934 744466  
email: sales@vado.com  
www.vado.com

where inspiration flows  
taps | showering | accessories



# TECHNICAL DRAWING

**COLLECTION:** ELEMENTS

**PRODUCT CODE:** ELE-148D/3-C/P

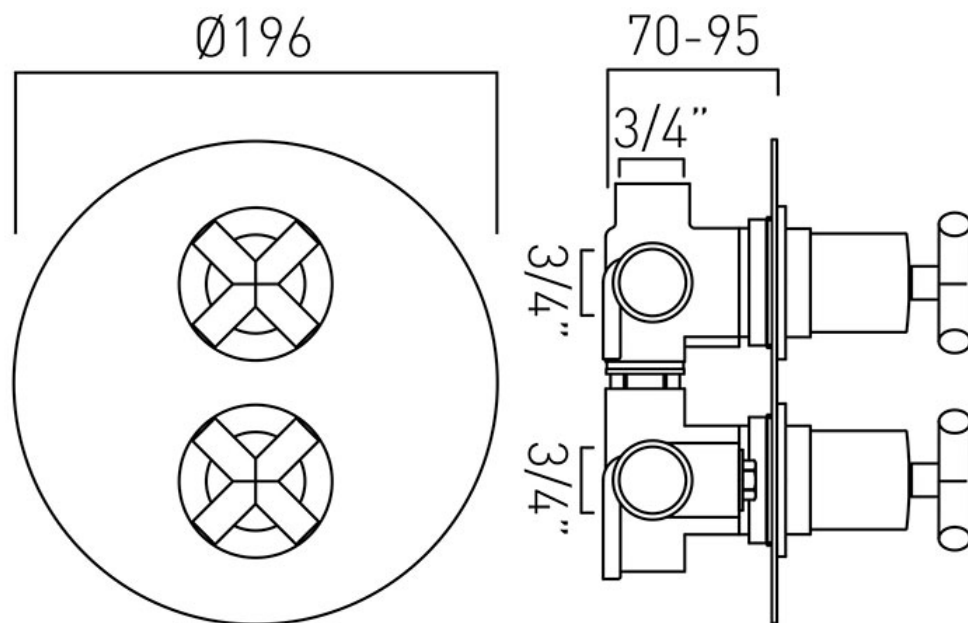

tel: 01934 744466  
email: [sales@vado.com](mailto:sales@vado.com)  
[www.vado.com](http://www.vado.com)

**where inspiration flows**  
taps | showering | accessories

